

A JAVID - CAROTID ARTERY CLAMP

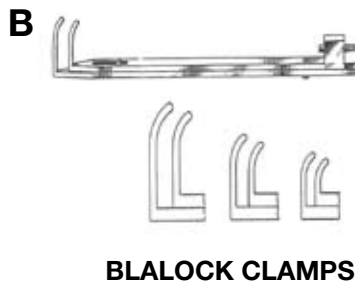

A Carotid Artery Clamp
M077-100 Small
M077-105 Large



B Blalock Clamp
M028-010 Small, 215mm
M028-015 Medium, 220mm
M028-020 Large, 225mm

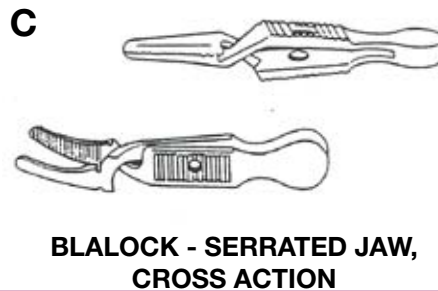

C Blalock Clamp, straight
G052-021 11mm jaw, 4cm
G052-023 14mm jaw, 4.5cm
G052-025 17mm jaw, 6cm
G052-027 27mm jaw, 7cm
G052-029 38mm jaw, 7.5mm
Blalock Clamp, curved
G052-020 11mm jaw, 4cm
G052-022 14mm jaw, 4.5cm
G052-024 17mm jaw, 6cm
G052-026 27mm jaw, 7cm
G052-028 38mm jaw, 7.5mm



D Setting Forceps - Bulldog
M064-675 23cm length

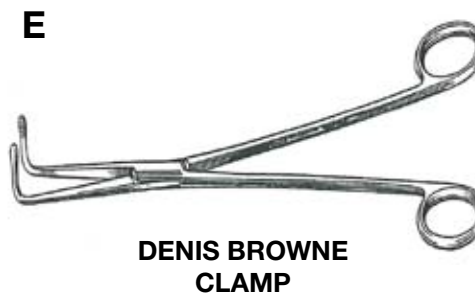

E Denis Browne Clamp
M028-178 45° angle jaw
M028-180 90° angle jaw

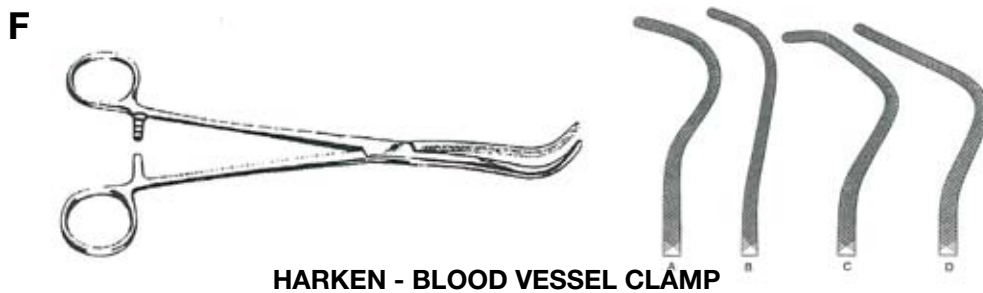

F Harken - Blood Vessel Clamp 23cm
A - M028-301
B - M028-302
C - M028-303
D - M028-304



G Price Thomas Bronchus Clamp
G017-040 double angled, left 22cm
G017-042 double angled, right 22cm
G017-044 double angled, 22cm without spikes

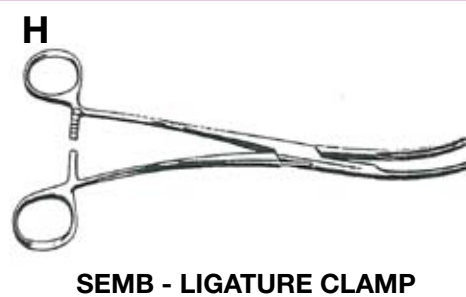

H Semb - Ligature Clamp
Distal eye for suture
M028-810 full curve, length 24cm
M028-812 shallow curve, length 24cm

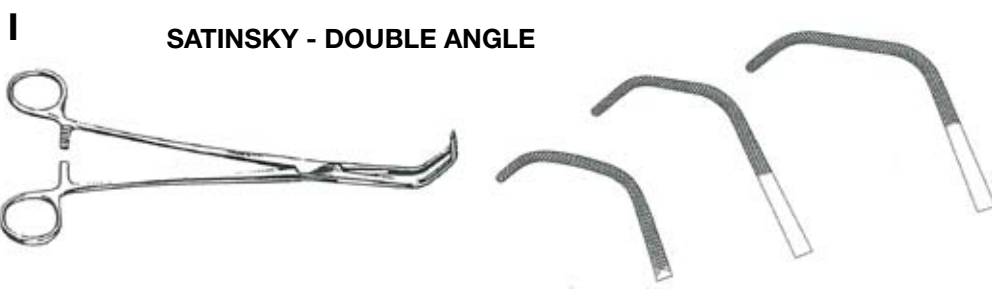

I Satinsky Clamps
Double angle, 26.5cm
M028-675 A, small angle
M028-680 B, large angle
Satinsky - Baby
Double angle
M028-685 length 15cm

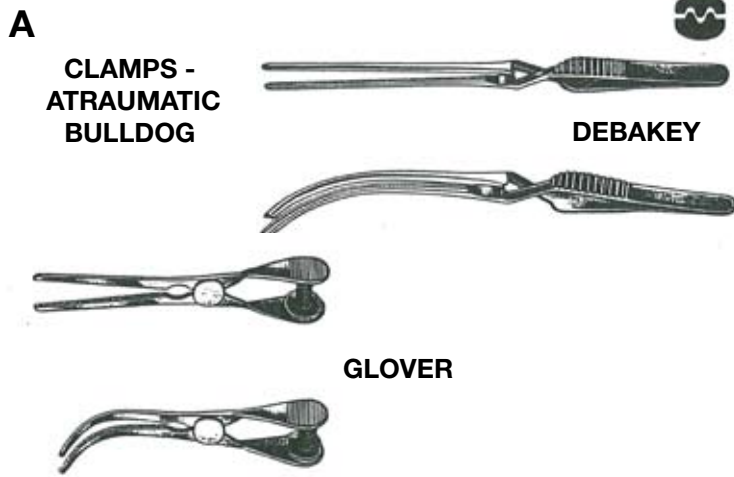

A DeBakey Clamps
M030-190 straight, 7.5cm
M030-192 straight, 8.5cm
M030-194 straight, 10.5cm
M030-196 straight, 12.0cm

M030-198 curved, 7.5cm
M030-200 curved, 8.5cm
M030-202 curved, 10.5cm
M030-204 curved, 12.0cm

Glover Clamps
M030-206 straight, 6cm
M030-208 straight, 7cm
M030-210 straight, 9cm
M030-212 straight, 11cm

M030-214 curved, 6cm
M030-216 curved, 7cm
M030-218 curved, 9cm
M030-220 curved, 11cm

B Cooley - Clamps
M030-018
 Anastomosis, 17cm

C Cooley - Derra Clamps
M030-020 small, 16cm
M030-022 medium, 17cm
M030-024 large, 18cm

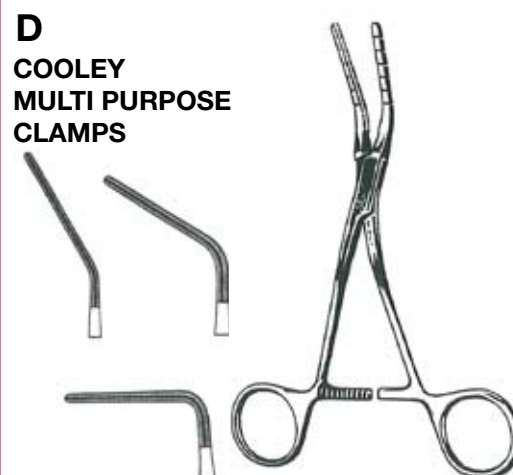
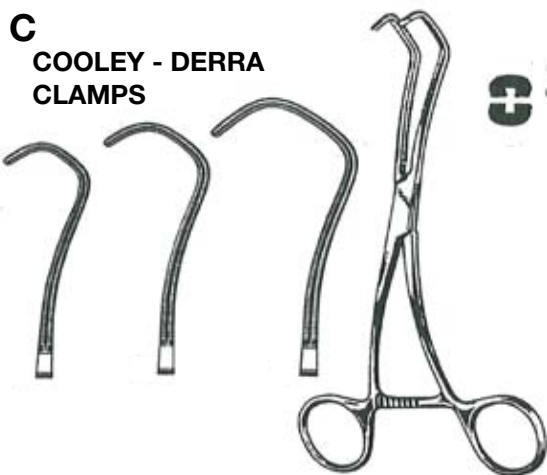

D Cooley Multi Purpose Clamps
M030-040 30°, 17cm
M030-042 60°, 16cm
M030-044 90°, 15cm



E Cooley Anastomosis Clamps
M030-030
 double angle, 17cm
M030-032
 double angle, 17cm

F Cooley Ligature Clamps
M030-060 16cm
M030-070 17cm



G Cooley - Ductus Clamps
M030-050 straight, 17cm
M030-052 curved, 17cm
M030-054 angled, 17cm
M030-056 spoon shape, 17cm



COOLEY - PAEDIATRIC CLAMPS

- H Cooley - Paediatric Clamp**
M030-072 straight, 14cm
M030-074 angled, 14cm
M030-076 double angled, 14cm
M030-078 spoon shape, 16cm

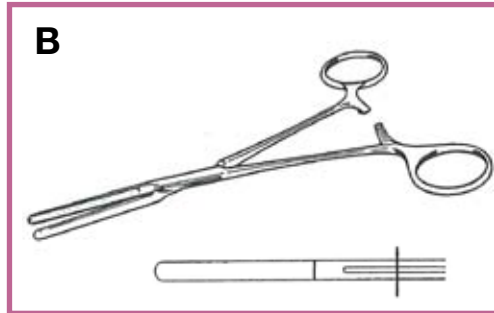
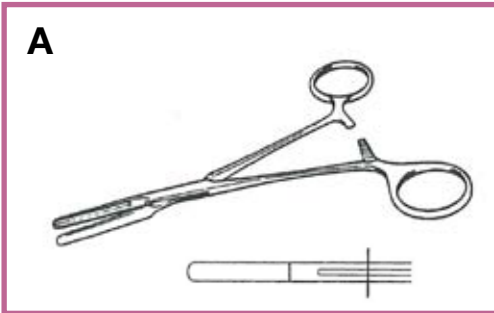

DARDIK CLAMP
Multi Purpose

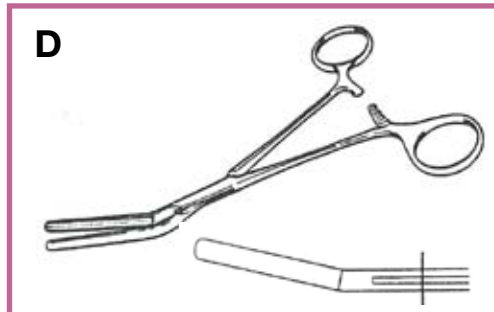
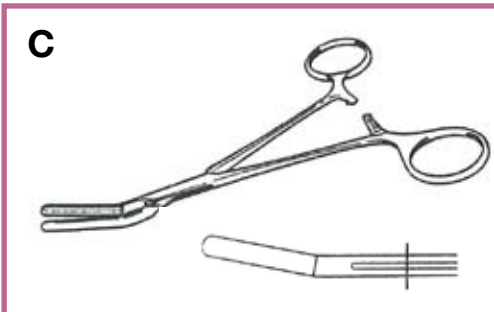

- A M030-102** straight, 15cm

- B M030-104** straight, 17cm

- C M030-106** 15° angle, 15cm

- D M030-108** 15° angle, 17cm

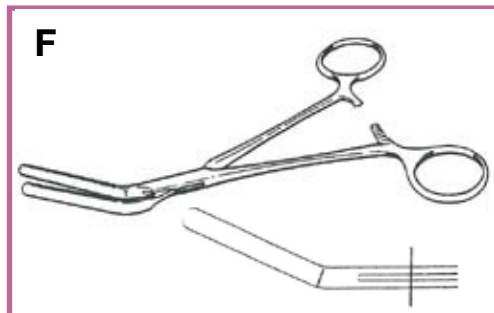
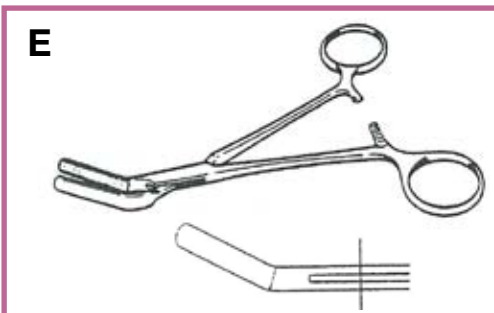

- E M030-110** 30° angle, 15cm

- F M030-112** 30° angle, 17cm

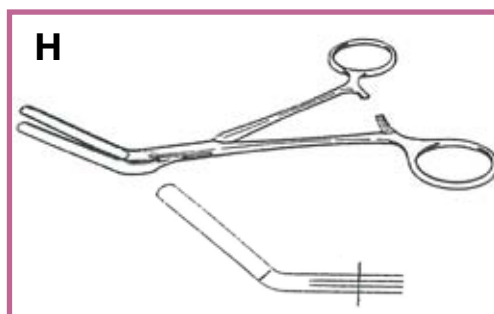
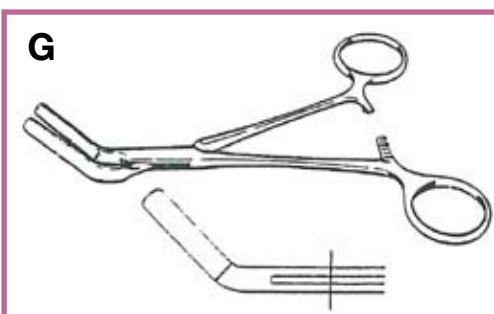

- G M030-114** 50° angle, 15cm

- H M030-116** 50° angle, 17cm

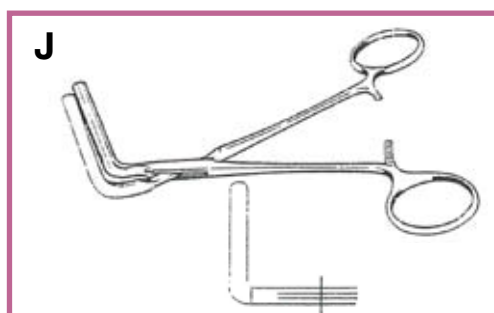
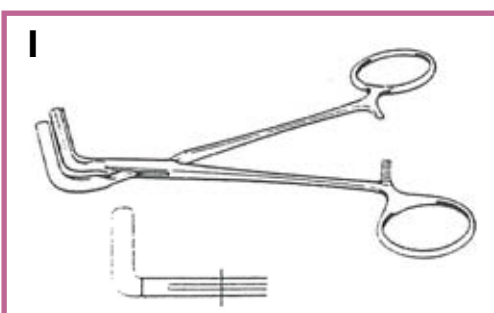

- I M030-118** 90° angle, 15cm

- J M030-120** 90° angle, 17cm

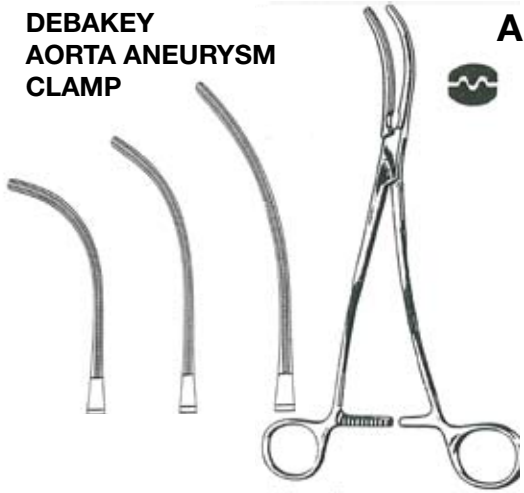
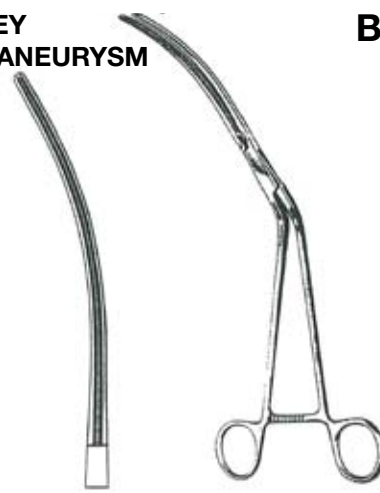
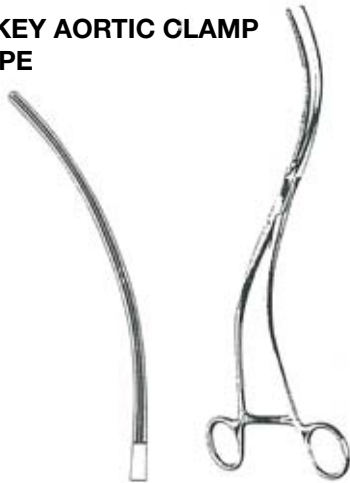
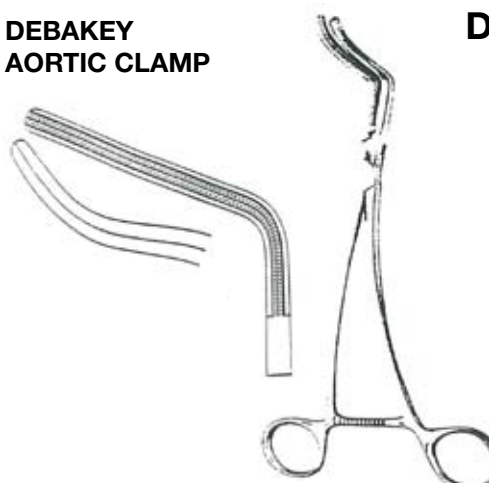
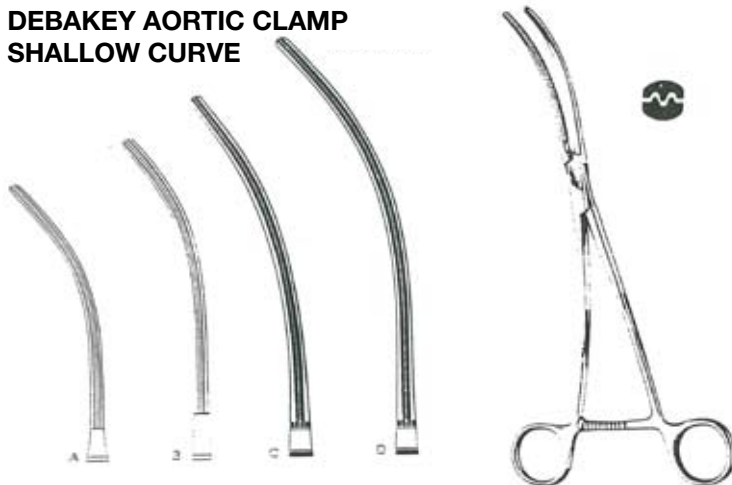
**DEBAKEY
AORTA ANEURYSM
CLAMP****A****DEBAKEY
AORTA ANEURYSM
CLAMP****B****DEBAKEY AORTIC CLAMP
S SHAPE****C****DEBAKEY
AORTIC CLAMP****D****DEBAKEY AORTIC CLAMP
SHALLOW CURVE****E****Debakey Derra
Anastomosis Clamp**

M030-182 A, 17cm
M030-184 B, 17cm
M030-186 C, 17cm

**Debakey Bainbridge
Clamp**

M030-690 straight, 40mm jaw, 15cm
M030-694 straight, 60mm jaw, 18cm
M030-692 curved, 40mm jaw, 15cm
M030-696 curved, 60mm jaw, 18cm

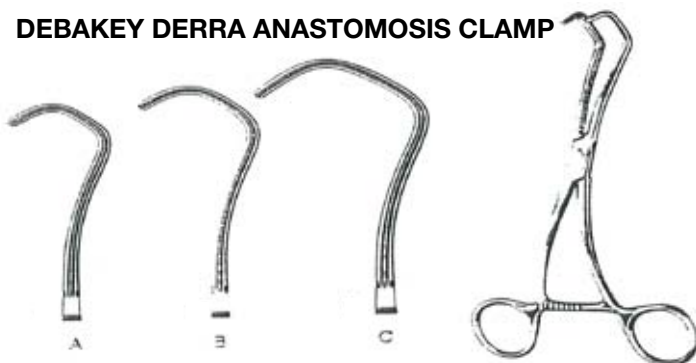
DEBAKEY DERRA ANASTOMOSIS CLAMP**DEBAKEY BAINBRIDGE CLAMP****A Debakey
Aorta Aneurysm Clamp**

M030-150 full curve, 24.5cm
M030-152 medium curve
M030-154 slight curve,
 26.5cm

**B Debakey
Aorta Aneurysm Clamp**

M030-158 24cm
M030-160 30cm

**C Debakey Aortic Clamp
S - shape**

M030-164 18.5cm
M030-166 30cm

D Debakey Aortic Clamp

M030-176 angled spoon,
 26.5cm

**E Debakey Aortic Clamp
Shallow curve**

M030-168 A, 24cm length
M030-170 B, 27cm length
M030-172 C, 31cm length
M030-174 D, 33.5cm length

A DEBAKEY MULTI PURPOSE CLAMP

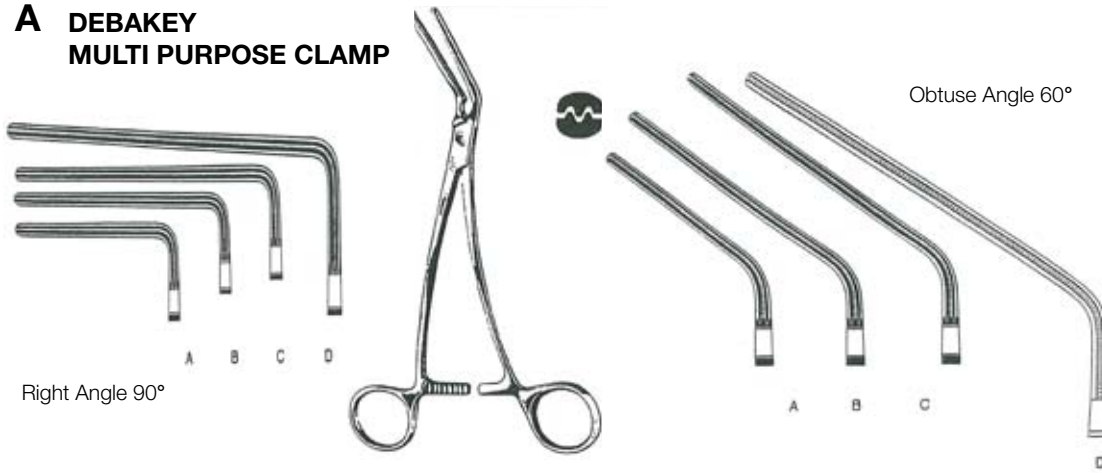

Right Angle 90°

Obtuse Angle 60°

A Debakey Multi Purpose Clamp Right Angle 90°

- M030-221 A 18cm length
- M030-222 B 19cm length
- M030-223 C 23cm length
- M030-224 D 27.5cm length

Debakey Obtuse Angle 60°

- M030-226 A 20cm length
- M030-227 B 22cm length
- M030-228 C 24cm length
- M030-229 D 30cm length

B Debakey - Ring Handle Bulldog Clamp

- M030-230 straight, 12cm
- M030-232 curve, 11cm
- M030-234 S-shape, 12cm
- M030-236 angled, 13cm
- M030-238 right angle, 10cm

B DEBAKEY RING HANDLE BULLDOG CLAMP

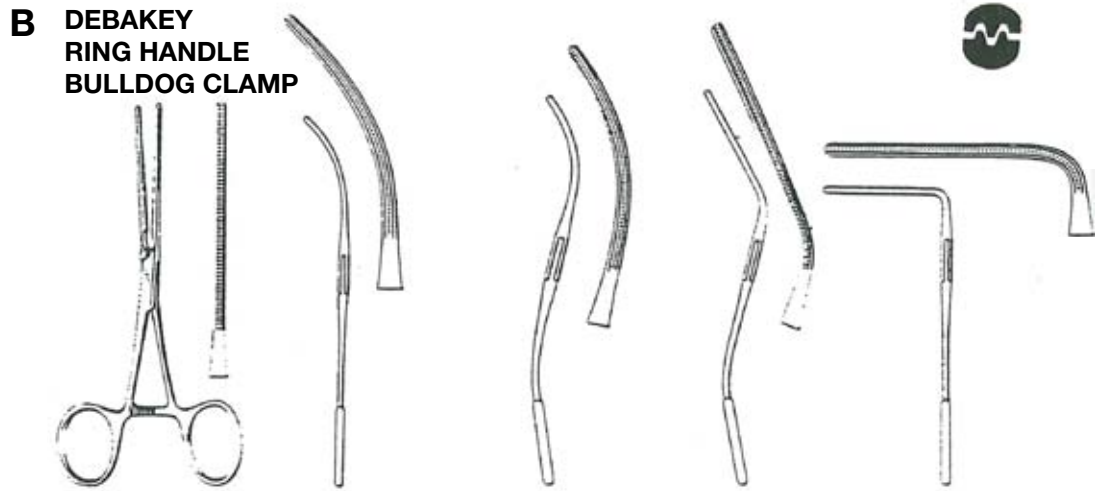

C Debakey - Curved Ligature Clamp

- M030-246 20cm length
- M030-248 24cm length

C DEBAKEY LIGATURE CLAMP

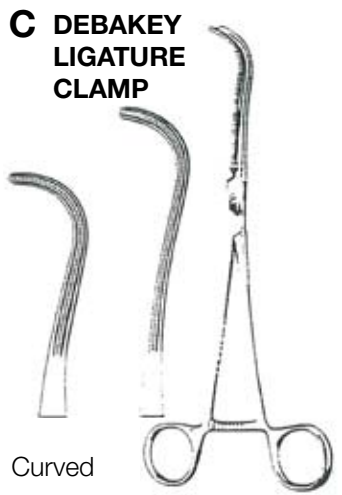

Curved

D DEBAKEY LIGATURE CLAMP

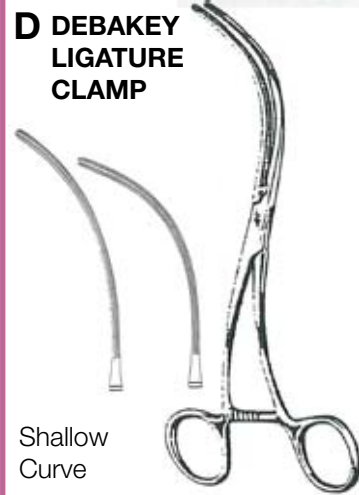

Shallow Curve

E DEBAKEY LIGATURE CLAMP



Full Curve

D Debakey - Shallow Curve Ligature Clamp

- M030-250 20cm length
- M030-252 19cm length

E Debakey - Full Curve Ligature Clamp

- M030-260 24cm length
- M030-262 26.5cm length full serration

F Debakey Coarctation Clamp

- M030-700 straight, 21cm
- M030-702 straight, 23cm
- M030-704 straight, 27cm
- M030-706 straight, 30cm
- M030-708 curved, 21cm
- M030-710 curved, 23cm
- M030-712 curved, 27cm
- M030-714 curved, 30cm

F DEBAKEY COARCTATION CLAMP

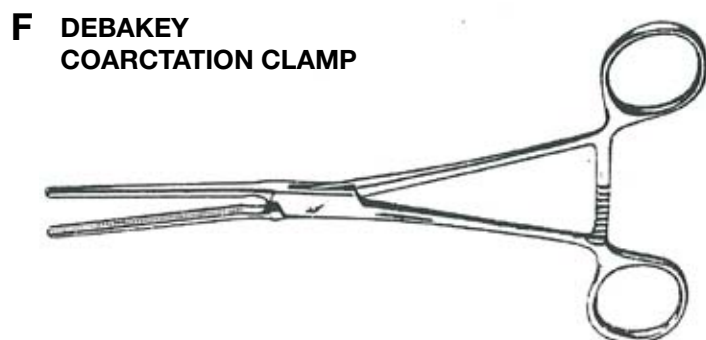

G DEBAKEY SEMB LIGATURE CLAMP

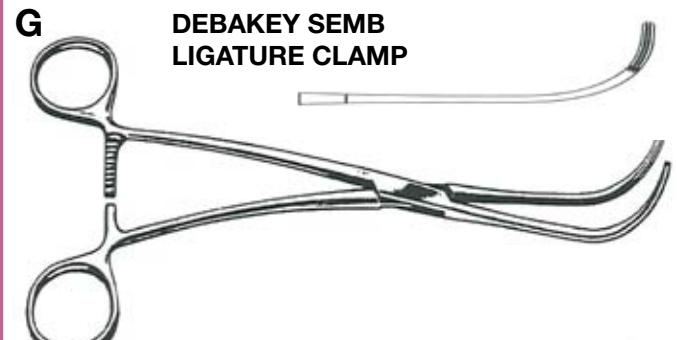

G Debakey Semb Ligature Clamp

- M030-264 25cm length

A DEBAKEY TANGENTIAL OCCLUSION CLAMP

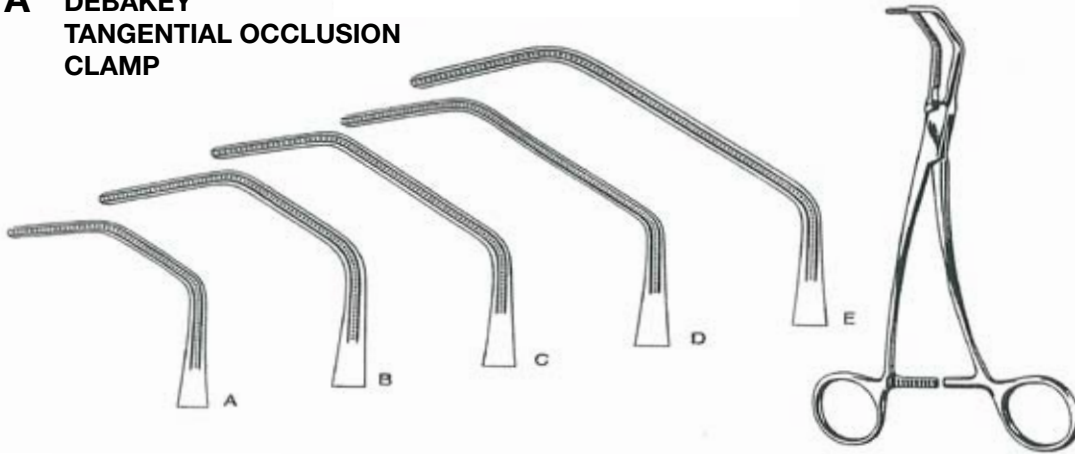

A Debakey Tangential Occlusion Clamp

M030-270 A 20cm length
M030-272 B 25cm length
M030-274 C 26cm length
M030-276 D 27cm length
M030-278 E 28cm length

B GLOVER COARCTATION CLAMP



B Glover Coarctation Clamp

M030-300
 straight, 55mm jaw, 22cm
M030-304
 straight, 70mm jaw, 25cm
M030-302
 angled, 55mm jaw, 22cm
M030-306
 angled, 70mm jaw, 25cm
M030-308
 right angle curve, 18.5cm
M030-312
 shallow curve, 21cm
M030-316
 spoon shape, 21cm
M030-310
 right angle curve, 20cm
M030-314
 shallow curve, 24cm
M030-318
 spoon shape, 24cm

C Leland Jones Peripheral Clamp

M030-675 straight, 19.5cm
M030-680 angled, 15°, 19.5cm
M030-685 angled, 30°, 19.5cm
M030-687 angled, 45°, 18.5cm

C LELAND JONES PERIPHERAL CLAMP



D WEBER AORTIC FULL CURVE CLAMP

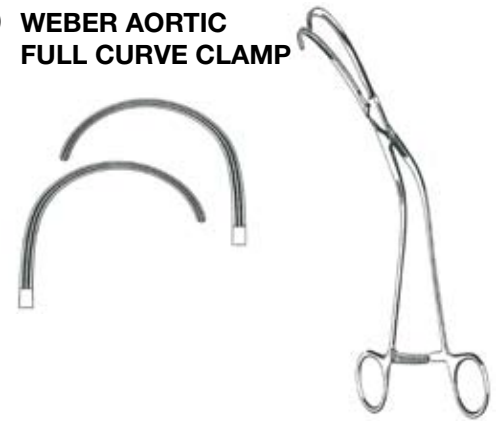

D Weber Aortic Full - curve Clamp

M030-605 left, 26cm
M030-610 right, 26cm

E Potts Coarctation Clamp

M030-320
 straight, half serration, 21cm
M030-322
 straight, full serration, 22cm
M030-324
 angled shank, half serration, 21cm
M030-326
 angled shank, full serration, 22cm

E POTTS COARCTATION CLAMP



F POTTS COARCTATION CLAMP

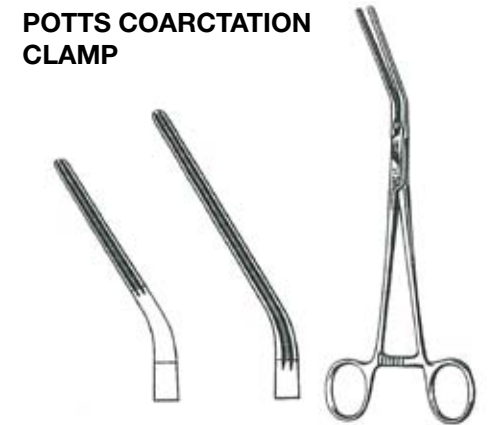

F Potts Coarctation Clamp

M030-328
 angled, half serration, 21cm
M030-330
 angled, full serration, 22cm

A SATINSKY CLAMP



B COOLEY NEONATAL - MINIATURE CLAMP

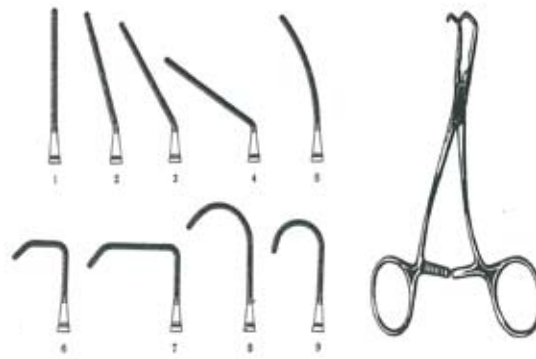

C CASTANEDA NEONATAL - MULTI PURPOSE CLAMP

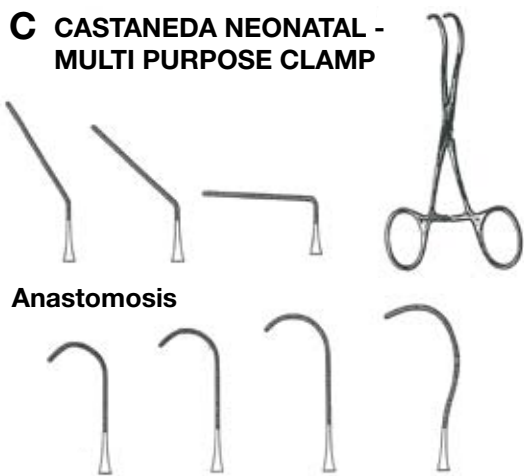

Anastomosis

D MOSQUITO - ATRAUMATIC HEMOSTATIC FORCEPS

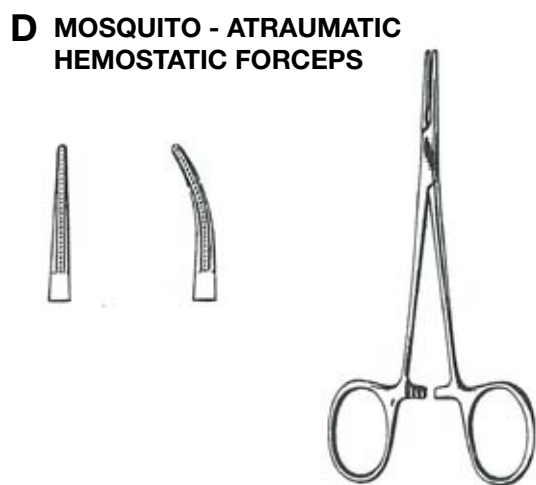

E PEAN - ATRAUMATIC HEMOSTATIC FORCEPS

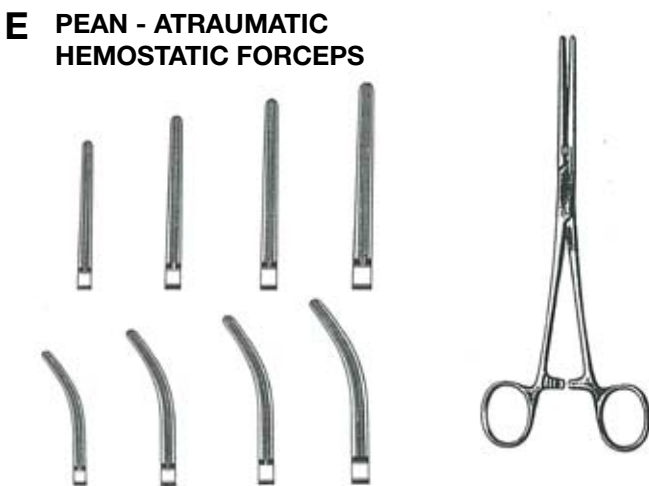

F DEBAKEY - ATRAUMATIC DISSECTING FORCEPS

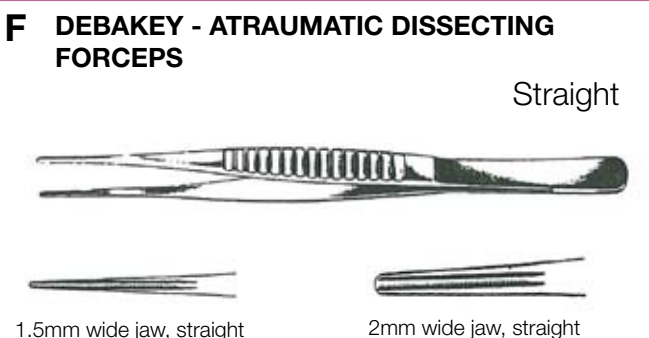

Straight

1.5mm wide jaw, straight

2mm wide jaw, straight

A Satinsky Clamp

25.5cm length
M030-410 small
M030-415 medium
M030-420 large

B Cooley Neonatal Miniature Clamp

M030-501 No 1
M030-502 No 2
M030-503 No 3
M030-504 No 4
M030-505 No 5
M030-506 No 6
M030-507 No 7
M030-508 No 8
M030-509 No 9

C Castaneda Neonatal Multi Purpose Clamp

M030-901
 angled 30°, 13cm
M030-902
 angled 50°, 13cm
M030-903
 angled, 90°, 13cm

Anastomosis

M030-904
 curved, small, 15cm
M030-905
 curved, medium, 15cm
M030-906
 curved, large, 15cm
M030-907
 curved, extra large, 15cm

D Mosquito - Atraumatic Hemostatic Forceps

M040-210 straight 12cm
M040-215 curved 12cm

E Pean - Atraumatic Hemostatic Forceps

M040-220 straight, 14cm
M040-222 straight, 16cm
M040-224 straight, 18cm
M040-226 straight, 20cm
M040-228 curved, 14cm
M040-230 curved, 16cm
M040-232 curved, 18cm
M040-234 curved, 20cm

F DeBakey - Atraumatic Dissecting Forceps

G062-180 15cm length 1.5mm
G062-182 18cm length 1.5mm
G062-184 20cm length 1.5mm
G062-186 25cm length 1.5mm
G062-187 30cm length 1.5mm
G062-196 15cm length 2mm
G062-198 18cm length 2mm
G062-200 20cm length 2mm
G062-202 25cm length 2mm
G062-204 30cm length 2mm

G DeBakey - Atraumatic Dissecting Forceps Angled

G062-204 15cm length 2mm
G062-206 18cm length 2mm
G062-208 20cm length 2mm
G062-210 25cm length 2mm
G062-212 30cm length 2mm

G DEBAKEY - ATRAUMATIC DISSECTING FORCEPS ANGLED

