

LARYNGOSCOPES

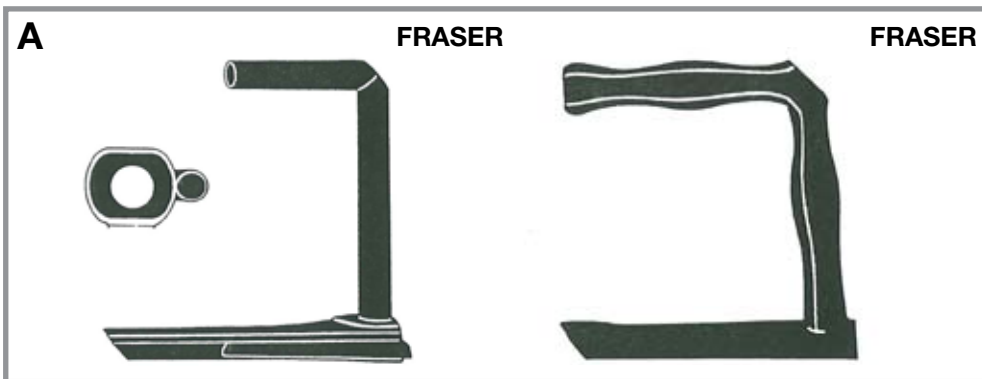

A Fraser Laryngoscopes
With single side tube for Fibre Light Carrier (not included), black finish

E128-010 101mm effective length, for Neonates and Infants

E128-015 108mm effective length, for Children

E128-020 138mm effective length, for Small Adult

E128-025 150mm effective length, for Adult

E128-030 150mm effective length, for Adult with difficult teeth

E128-040 Fibre Light Carrier for Fraser Laryngoscope (not illustrated)



B Gabriel Laryngoscopes
Anterior Commissure with beak end. Single side tube for Fibre Light Carrier (not included), black finish

E128-110 120 effective length, small

E128-115 150 effective length, medium

E128-120 150 effective length, large

E128-125 Fibre Light Carrier for Gabriel Laryngoscopes (not illustrated)

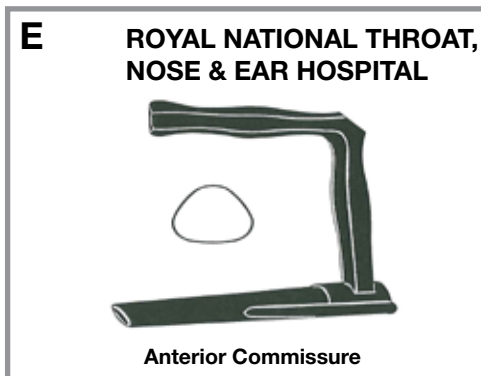
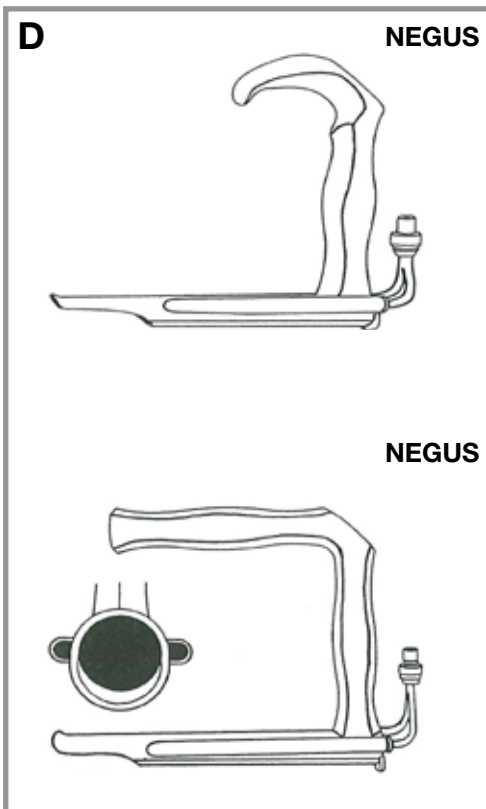

C Royal National Throat, Nose & Ear Hospital
With single side tube for Fibre Light Carrier (not included), black finish

E128-305 120 effective length, small

E128-310 150 effective length, medium

E128-315 152 effective length, large

E Royal National Throat, Nose & Ear Hospital Anterior Commissure
With single side tube for Fibre Light Carrier (not included), black finish

E128-405 123 effective length, small

E128-410 149 effective length, medium

E128-415 149 effective length, large

E128-500 Fibre Light Carrier for R.N.T.N.E. Laryngoscope (not illustrated)

D Negus Laryngoscopes
With removable sliding panel, complete with twin Fibre Light Carrier, polished brass

E128-520 10 x 10mm, 82mm effective length, for Infant

E128-525 12 x 12mm, 99mm effective length, for Child

E128-530 15 x 15mm, 135mm effective length, for Adult

E128-620 Fibre Light Carrier only, Infant

E128-625 Fibre Light Carrier only, Child

E128-630 Fibre Light Carrier only, Adult

BRONCHOSCOPES

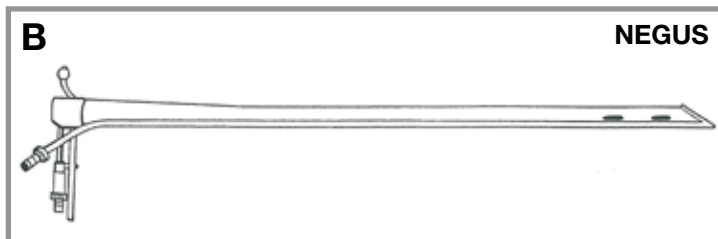
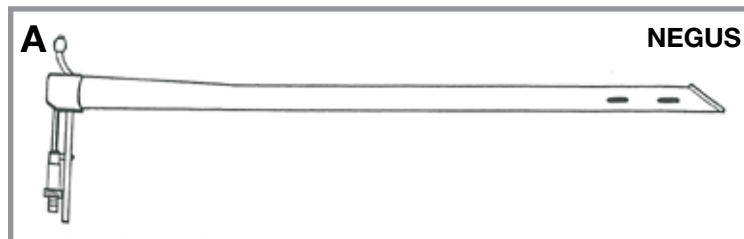
**A Negus Bronchoscope**

Fitted with Venturi Needle, complete with Fibre Light Carrier.
Polished Brass

- E006-105** 18.0cm eff. length 3.7mm int. dia. Suckling Short
E006-110 27.5cm eff. length 3.7mm int. dia. Suckling Small
E006-115 27.5cm eff. length 4.1mm int. dia. Suckling
E006-120 27.5cm eff. length 5.4mm int. dia. Infant
E006-125 30.0cm eff. length 7.0mm int. dia. Child
E006-130 40.0cm eff. length 7.0mm int. dia. Adolescent Small
E006-135 40.0cm eff. length 8.0mm int. dia. Adolescent
E006-140 40.0cm eff. length 9.0mm int. dia. Adult Small
E006-145 40.0cm eff. length 10mm int. dia. Adult
E006-150 45.0cm eff. length 6.4mm int. dia. Lower Bronchus

B Negus Bronchoscope

Fitted with Venturi Needle, complete with Fibre Light Carrier.
Polished Brass

- E006-155** 30.0cm eff. length 6.5mm int. dia. Child, Aspirating
E006-160 40.0cm eff. length 7.5mm int. dia. Adult, Aspirating
E006-200 Fibre Light Carrier only, for 40.0cm Bronchoscopes
E006-202 Fibre Light Carrier only, for 30.0cm Bronchoscopes
E006-204 Fibre Light Carrier only,
for 27.5cm Bronchoscopes, Infant
E006-206 Fibre Light Carrier only,
for 27.5cm Bronchoscopes, Suckling
E006-208 Fibre Light Carrier only, for 18.0cm Bronchoscopes
E006-210 Fibre Light Carrier only, for 45.0cm Bronchoscopes

OESOPHAGOSCOPES

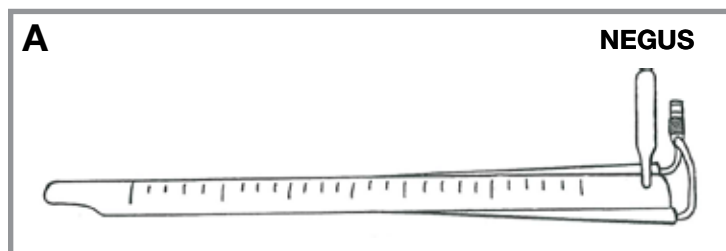
**A Negus Oesophagoscopes**

Complete with twin Fibre Light Carrier, polished brass

- E146-325** 5.6 x 6.6mm Lumen, 20cm, infant, small
E146-330 7.6 x 8.6mm Lumen, 20cm, infant
E146-335 8.0 x 10.0mm Lumen, 25cm, child, short
E146-340 8.0 x 10.0mm Lumen, 35cm, child
E146-345 9.6 x 11.6mm Lumen, 25cm, adolescent, short
E146-350 9.6 x 11.6mm Lumen, 35cm, adolescent
E146-355 13.6 x 15.6mm Lumen, 35cm, adult, short
E146-360 11.6 x 13.6mm Lumen, 45cm, adult, long
E146-365 15.6 x 17.6mm Full Lumen, 45cm, adult, long
E146-370 15.6 x 17.6mm Lumen, 53cm, adult, extra long
E146-425 Fibre Light Carrier only, infant, small
E146-430 Fibre Light Carrier only, infant
E146-435 Fibre Light Carrier only, child, short
E146-440 Fibre Light Carrier only, child
E146-445 Fibre Light Carrier only, adolescent, short
E146-450 Fibre Light Carrier only, adolescent
E146-455 Fibre Light Carrier only, adult, short
E146-460 Fibre Light Carrier only, adult, long
E146-465 Fibre Light Carrier only, adult, long (Full Lumen)
E146-470 Fibre Light Carrier only, adult, extra long

Please Note: All Oesophagoscopes:

- Can be supplied in Stainless Steel
- Can also be fitted with Conventional Lighting

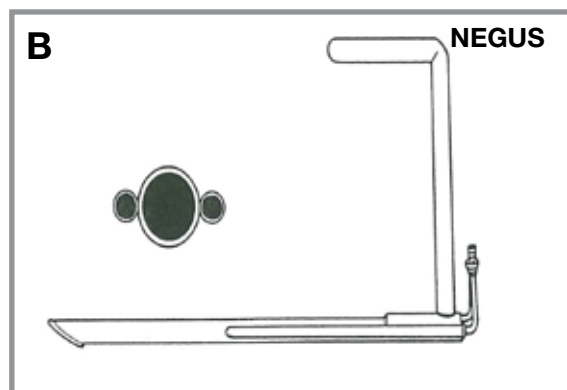
**B Negus Tracheoscope**

Complete with twin Fibre Light Carrier
Polished brass

- E146-650** 16.0cm effective length, Child
E146-655 22.0cm effective length, Adult
E146-700 Fibre Light Carriers only
for E146-610, 625, 630 & 640
E146-705 Fibre Light Carriers only
for E146-620 & 635
E146-710 Fibre Light Carriers only
for E146-650 & 660
E146-715 Fibre Light Carriers only
for E146-655 & 665

OESOPHAGOSCOPES Cont'd

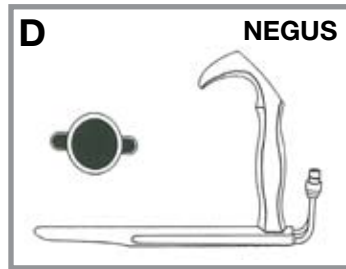
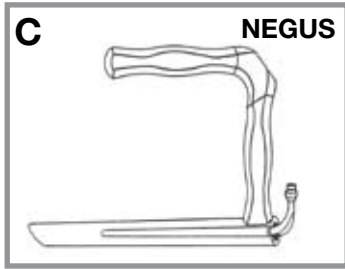

C Negus Oesophageal Speculum
Complete with twin Fibre Light Carrier, polished brass
E146-610 13.0mm x 11.0mm Lumen, 20cm effective length, Adult

D Negus Oesophageal Speculum
Complete with twin Fibre Light Carrier and long bevelled end, polished brass
E146-620 13.0mm Lumen, 15cm effective length, Child
E146-625 13.0mm Lumen, 22cm effective length, Adult

MIRRORS - LARYNGEAL

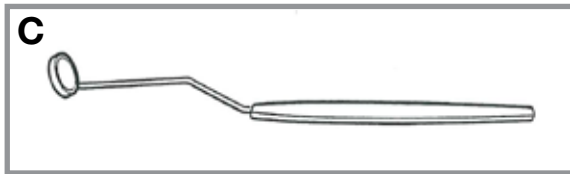
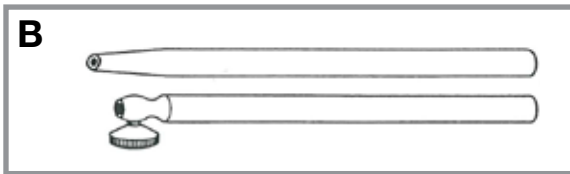
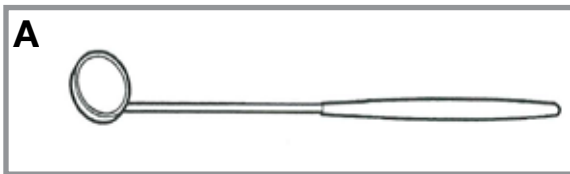

A Mirror
With fixed handle
E134-106 6mm dia **E134-120** 20mm dia
E134-108 8mm dia **E134-122** 22mm dia
E134-110 10mm dia **E134-124** 24mm dia
E134-112 12mm dia **E134-126** 26mm dia
E134-114 14mm dia **E134-128** 28mm dia
E134-116 16mm dia **E134-130** 30mm dia
E134-118 18mm dia **E034-140** Set of 13 sizes 6mm - 30mm

B Mirror Handle
E134-205 mirror handle only
E134-210 mirror handle, screw adjustment

C St Clair Thomson Rhinoscopic
E134-406 6mm dia
E134-408 8mm dia
E134-410 10mm dia
E134-412 12mm dia
E134-414 14mm dia
E134-416 16mm dia

D Laryngoscope Head Mirror
Ball & Socket fitting, adjustable webbing headband and 9cm dia mirror
G012-120
Head Mirror
with wide plastic headband
G012-110 (not illustrated)

E Mirror Only
E134-306 6mm dia
E134-308 8mm dia
E134-310 10mm dia
E134-312 12mm dia
E134-314 14mm dia
E134-316 16mm dia
E134-318 18mm dia
E134-320 20mm dia
E134-322 22mm dia
E134-324 24mm dia
E134-326 26mm dia
E134-328 28mm dia
E134-330 30mm dia
E134-420 Set of 6 sizes 6mm - 16mm

MYRINGOTOME

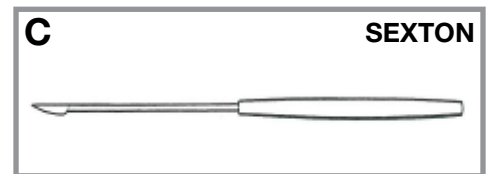
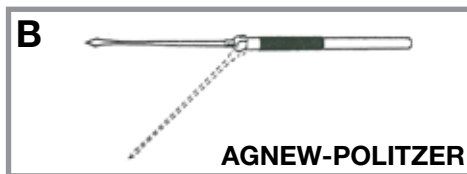
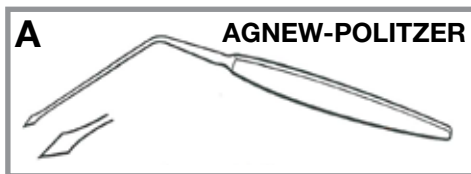

A Agnew-Politzer Myringotome
Angled
E138-105 19cm

B Agnew-Politzer Myringotome
Reversible, adjustable, straight to angled
E138-205

C Sexton Myringotome
Straight shaft, small blade
E138-305 18cm

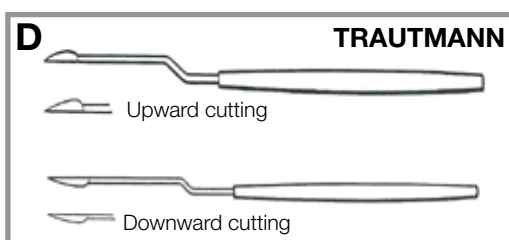

D Trautmann Myringotome
E138-405 upward cutting, 18cm
E138-410 downward cutting, 18cm