

## LARYNGOSCOPES

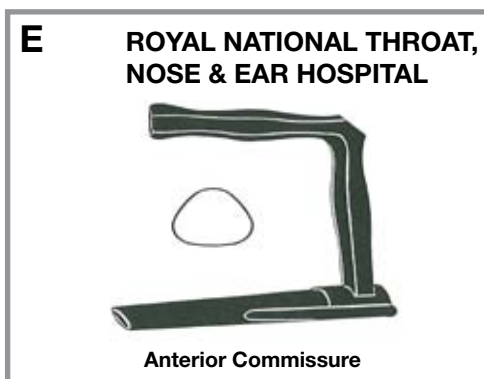
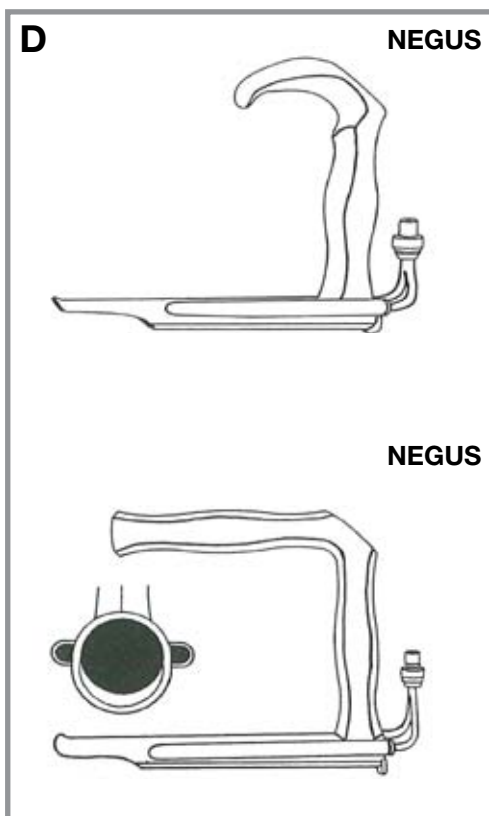
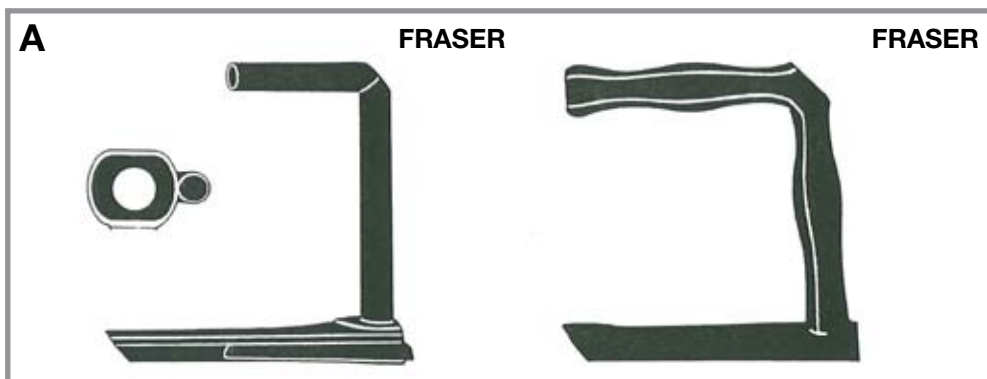

**E Royal National Throat, Nose & Ear Hospital Anterior Commissure**  
With single side tube for Fibre Light Carrier (not included), black finish

- E128-405** 123 effective length, small
- E128-410** 149 effective length, medium
- E128-415** 149 effective length, large
- E128-500** Fibre Light Carrier for R.N.T.N.E. Laryngoscope (not illustrated)

**A Fraser Laryngoscopes**  
With single side tube for Fibre Light Carrier (not included), black finish

- E128-010** 101mm effective length, for Neonates and Infants
- E128-015** 108mm effective length, for Children
- E128-020** 138mm effective length, for Small Adult
- E128-025** 150mm effective length, for Adult
- E128-030** 150mm effective length, for Adult with difficult teeth
- E128-040** Fibre Light Carrier for Fraser Laryngoscope (not illustrated)

**B Gabriel Laryngoscopes**  
Anterior Commissure with beak end. Single side tube for Fibre Light Carrier (not included), black finish

- E128-110** 120 effective length, small
- E128-115** 150 effective length, medium
- E128-120** 150 effective length, large
- E128-125** Fibre Light Carrier for Gabriel Laryngoscopes (not illustrated)

**C Royal National Throat, Nose & Ear Hospital**  
With single side tube for Fibre Light Carrier (not included), black finish

- E128-305** 120 effective length, small
- E128-310** 150 effective length, medium
- E128-315** 152 effective length, large

**D Negus Laryngoscopes**  
With removable sliding panel, complete with twin Fibre Light Carrier, polished brass

- E128-520** 10 x 10mm, 82mm effective length, for Infant
- E128-525** 12 x 12mm, 99mm effective length, for Child
- E128-530** 15 x 15mm, 135mm effective length, for Adult
- E128-620** Fibre Light Carrier only, Infant
- E128-625** Fibre Light Carrier only, Child
- E128-630** Fibre Light Carrier only, Adult

## BRONCHOSCOPES

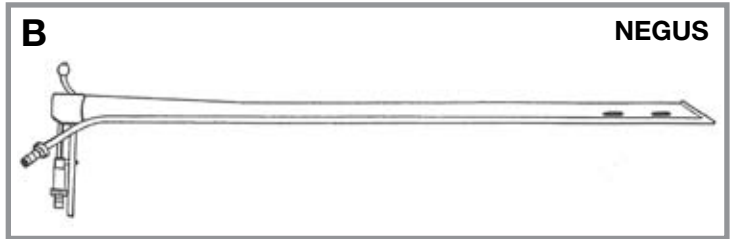
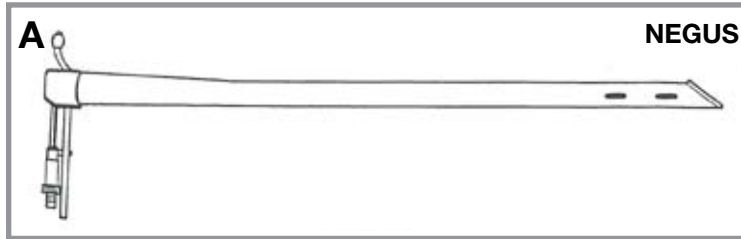
**A Negus Bronchoscope**

Fitted with Venturi Needle, complete with Fibre Light Carrier.  
Polished Brass

- E006-105** 18.0cm eff. length 3.7mm int. dia. Suckling Short  
**E006-110** 27.5cm eff. length 3.7mm int. dia. Suckling Small  
**E006-115** 27.5cm eff. length 4.1mm int. dia. Suckling  
**E006-120** 27.5cm eff. length 5.4mm int. dia. Infant  
**E006-125** 30.0cm eff. length 7.0mm int. dia. Child  
**E006-130** 40.0cm eff. length 7.0mm int. dia. Adolescent Small  
**E006-135** 40.0cm eff. length 8.0mm int. dia. Adolescent  
**E006-140** 40.0cm eff. length 9.0mm int. dia. Adult Small  
**E006-145** 40.0cm eff. length 10mm int. dia. Adult  
**E006-150** 45.0cm eff. length 6.4mm int. dia. Lower Bronchus

**B Negus Bronchoscope**

Fitted with Venturi Needle, complete with Fibre Light Carrier.  
Polished Brass

- E006-155** 30.0cm eff. length 6.5mm int. dia. Child, Aspirating  
**E006-160** 40.0cm eff. length 7.5mm int. dia. Adult, Aspirating  
**E006-200** Fibre Light Carrier only, for 40.0cm Bronchoscopes  
**E006-202** Fibre Light Carrier only, for 30.0cm Bronchoscopes  
**E006-204** Fibre Light Carrier only,  
for 27.5cm Bronchoscopes, Infant  
**E006-206** Fibre Light Carrier only,  
for 27.5cm Bronchoscopes, Suckling  
**E006-208** Fibre Light Carrier only, for 18.0cm Bronchoscopes  
**E006-210** Fibre Light Carrier only, for 45.0cm Bronchoscopes

## OESOPHAGOSCOPES

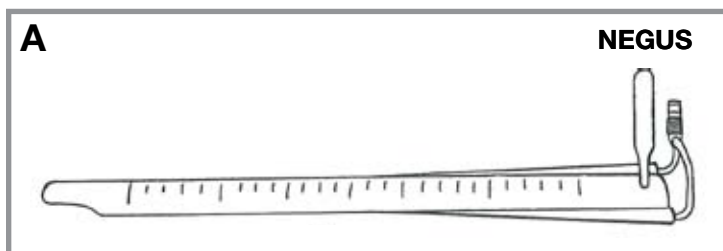
**A Negus Oesophoscopes**

Complete with twin Fibre Light Carrier, polished brass

- E146-325** 5.6 x 6.6mm Lumen, 20cm, infant, small  
**E146-330** 7.6 x 8.6mm Lumen, 20cm, infant  
**E146-335** 8.0 x 10.0mm Lumen, 25cm, child, short  
**E146-340** 8.0 x 10.0mm Lumen, 35cm, child  
**E146-345** 9.6 x 11.6mm Lumen, 25cm, adolescent, short  
**E146-350** 9.6 x 11.6mm Lumen, 35cm, adolescent  
**E146-355** 13.6 x 15.6mm Lumen, 35cm, adult, short  
**E146-360** 11.6 x 13.6mm Lumen, 45cm, adult, long  
**E146-365** 15.6 x 17.6mm Full Lumen, 45cm, adult, long  
**E146-370** 15.6 x 17.6mm Lumen, 53cm, adult, extra long  
**E146-425** Fibre Light Carrier only, infant, small  
**E146-430** Fibre Light Carrier only, infant  
**E146-435** Fibre Light Carrier only, child, short  
**E146-440** Fibre Light Carrier only, child  
**E146-445** Fibre Light Carrier only, adolescent, short  
**E146-450** Fibre Light Carrier only, adolescent  
**E146-455** Fibre Light Carrier only, adult, short  
**E146-460** Fibre Light Carrier only, adult, long  
**E146-465** Fibre Light Carrier only, adult, long (Full Lumen)  
**E146-470** Fibre Light Carrier only, adult, extra long

**Please Note: All Oesophoscopes:**

- Can be supplied in Stainless Steel
- Can also be fitted with Conventional Lighting

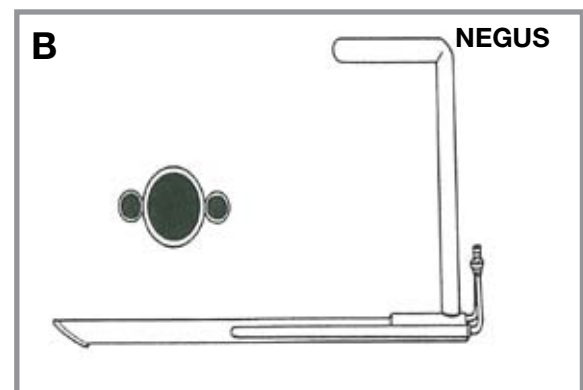
**B Negus Tracheoscope**

Complete with twin Fibre Light Carrier  
Polished brass

- E146-650** 16.0cm effective length, Child  
**E146-655** 22.0cm effective length, Adult  
**E146-700** Fibre Light Carriers only  
for E146-610, 625, 630 & 640  
**E146-705** Fibre Light Carriers only  
for E146-620 & 635  
**E146-710** Fibre Light Carriers only  
for E146-650 & 660  
**E146-715** Fibre Light Carriers only  
for E146-655 & 665

OESOPHAGOSCOPES Cont'd .....

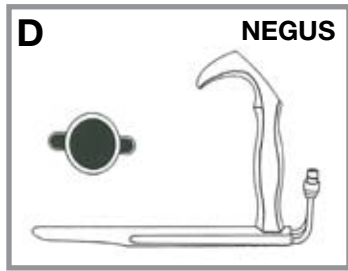
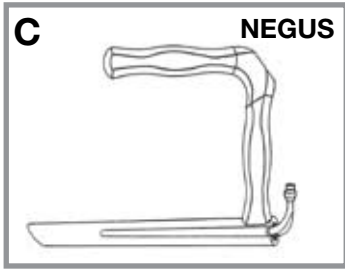

**C Negus Oesophageal Speculum**  
Complete with twin Fibre Light Carrier, polished brass  
**E146-610** 13.0mm x 11.0mm Lumen, 20cm effective length, Adult

**D Negus Oesophageal Speculum**  
Complete with twin Fibre Light Carrier and long bevelled end, polished brass  
**E146-620** 13.0mm Lumen, 15cm effective length, Child  
**E146-625** 13.0mm Lumen, 22cm effective length, Adult

MIRRORS - LARYNGEAL

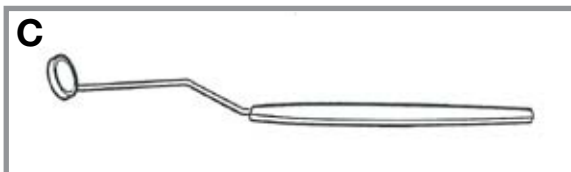
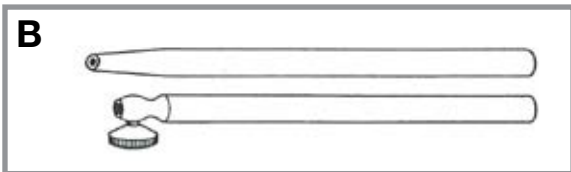
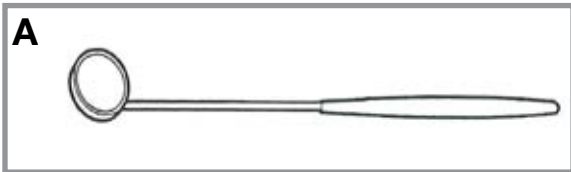

**A Mirror**  
With fixed handle  
**E134-106** 6mm dia **E134-120** 20mm dia  
**E134-108** 8mm dia **E134-122** 22mm dia  
**E134-110** 10mm dia **E134-124** 24mm dia  
**E134-112** 12mm dia **E134-126** 26mm dia  
**E134-114** 14mm dia **E134-128** 28mm dia  
**E134-116** 16mm dia **E134-130** 30mm dia  
**E134-118** 18mm dia **E034-140** Set of 13 sizes 6mm - 30mm

**B Mirror Handle**  
**E134-205** mirror handle only  
**E134-210** mirror handle, screw adjustment

**C St Clair Thomson Rhinoscopic**  
**E134-406** 6mm dia  
**E134-408** 8mm dia  
**E134-410** 10mm dia  
**E134-412** 12mm dia  
**E134-414** 14mm dia  
**E134-416** 16mm dia

**D Laryngoscope Head Mirror**  
Ball & Socket fitting, adjustable webbing headband and 9cm dia mirror  
**G012-120**  
**Head Mirror** with wide plastic headband  
**G012-110** (not illustrated)

**E Mirror Only**  
**E134-306** 6mm dia  
**E134-308** 8mm dia  
**E134-310** 10mm dia  
**E134-312** 12mm dia  
**E134-314** 14mm dia  
**E134-316** 16mm dia  
**E134-318** 18mm dia  
**E134-320** 20mm dia  
**E134-322** 22mm dia  
**E134-324** 24mm dia  
**E134-326** 26mm dia  
**E134-328** 28mm dia  
**E134-330** 30mm dia  
**E134-420** Set of 6 sizes 6mm - 16mm

MYRINGOTOME

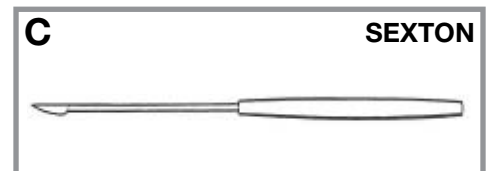
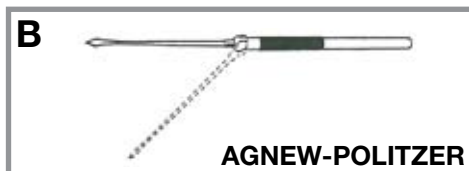
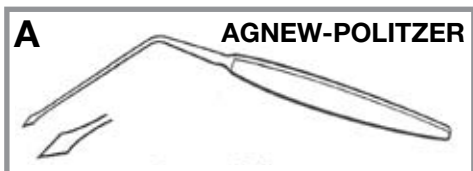

**A Agnew-Politzer Myringotome**  
Angled  
**E138-105** 19cm

**B Agnew-Politzer Myringotome**  
Reversible, adjustable, straight to angled  
**E138-205**

**C Sexton Myringotome**  
Straight shaft, small blade  
**E138-305** 18cm

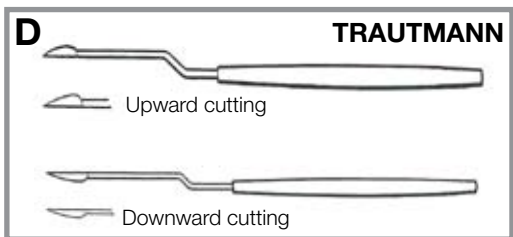

**D Trautmann Myringotome**  
**E138-405** upward cutting, 18cm  
**E138-410** downward cutting, 18cm