

**Judd Medical Limited** is proud to introduce its range of precision replacement saw blades and burs.

**Judd Medical has been a manufacturer and distributor of quality saw blades and burs since 1997 and has established itself as a leader in the UK Market by combining product quality and performance with cost effective pricing structures.**

We have an extensive portfolio of burs and blades that are compatible with all leading manufacturers power tool systems. All our products are supplied in sterile packaging and are sterilised via Gamma Irradiation offering a five year sterile shelf life complete with batch traceability labelling.

**All products meet  
CE Certification  
for Class IIb Products  
Sterile Packed**

Please find below a **selection** of our most popular ENT burs and blades, for further information, or to request a full bur and blade catalogue please contact our **Customer Service Team** on **+44(0)1527 559010**.

### OSTEON® - CARBIDE, DIAMOND & STAINLESS STEEL Type - Long Round Burs 48mm

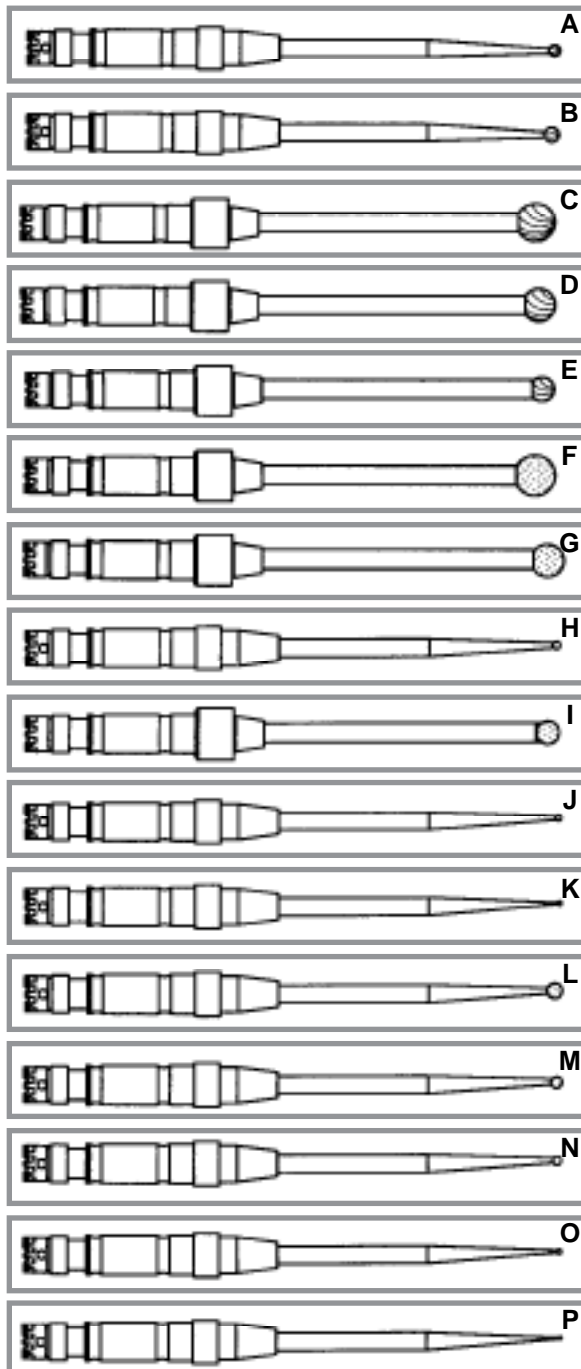



	Head Size	Flutes	Head Material	Judd Ref	MicroAire® Ref	Zimmer® Ref
<b>A</b>	1.5mm	6	S/Steel	<b>JMB-640</b>	ZB-640	5056-140
<b>B</b>	2.0mm	6	S/Steel	<b>JMB-642</b>	ZB-642	5056-142
<b>C</b>	5.0mm	10	Carbide	<b>JMB-644</b>	ZB-644	5056-144
<b>D</b>	4.0mm	8	Carbide	<b>JMB-645</b>	ZB-645	5056-145
<b>E</b>	3.0mm	8	Carbide	<b>JMB-646</b>	ZB-646	5056-146
<b>F</b>	5.0mm	N/A	Diamond	<b>JMB-650</b>	ZB-650	5056-150
<b>G</b>	4.0mm	N/A	Diamond	<b>JMB-652</b>	ZB-652	5056-152
<b>H</b>	1.0mm	N/A	Diamond	<b>JMB-658</b>	ZB-658	5056-158
<b>I</b>	3.0mm	N/A	Diamond	<b>JMB-659</b>	ZB-659	5056-159
<b>J</b>	0.7mm	N/A	Diamond	<b>JMB-660</b>	ZB-660	5056-160
<b>K</b>	0.5mm	N/A	Diamond	<b>JMB-661</b>	ZB-661	5056-161
<b>L</b>	2.0mm	N/A	Diamond	<b>JMB-662</b>	ZB-662	5056-162
<b>M</b>	1.5mm	N/A	Diamond	<b>JMB-663</b>	ZB-663	5056-163
<b>N</b>	1.0mm	6	S/Steel	<b>JMB-664</b>	ZB-664	5056-164
<b>O</b>	0.7mm	4	S/Steel	<b>JMB-665</b>	ZB-665	5056-165
<b>P</b>	0.5mm	4	S/Steel	<b>JMB-666</b>	ZB-666	5056-166

Available in 3 Lengths: 30mm, 38mm & 48mm



**OSTEON® - CARBIDE & DIAMOND**  
Type - Medium Length  
Round Burs 38mm

	Head Size	Flutes	Head Material	Judd Ref	MicroAire® Ref	Zimmer® Ref
	<b>A</b> 6.5mm	10	Carbide	<b>JMB-625</b>	ZB-625	5056-125
	<b>B</b> 5.0mm	10	Carbide	<b>JMB-626</b>	ZB-626	5056-126
	<b>C</b> 4.0mm	8	Carbide	<b>JMB-627</b>	ZB-627	5056-127
	<b>D</b> 3.0mm	8	Carbide	<b>JMB-628</b>	ZB-628	5056-128
	<b>E</b> 5.0mm	N/A	Diamond	<b>JMB-647</b>	ZB-647	5056-147
	<b>F</b> 4.0mm	N/A	Diamond	<b>JMB-648</b>	ZB-648	5056-148



**OSTEON® - CARBIDE**  
Type - Short Length  
Round Burs 30mm

	Head Size	Flutes	Head Material	Judd Ref	MicroAire® Ref	Zimmer® Ref
	<b>A</b> 6.5mm	10	Carbide	<b>JMB-617</b>	ZB-617	5056-117
	<b>B</b> 5.0mm	10	Carbide	<b>JMB-618</b>	ZB-618	5056-118
	<b>C</b> 4.0mm	8	Carbide	<b>JMB-619</b>	ZB-619	5056-119

**OSTEON® - DIAMOND**  
Type - Dermabrader Burs 30mm

	Head Size	Flutes	Head Material	Judd Ref	MicroAire® Ref	Zimmer® Ref
	<b>A</b> 4.0mm	N/A	Diamond	<b>JMB-680</b>	ZB-680	5056-180
	<b>B</b> 7.0mm	N/A	Diamond	<b>JMB-681</b>	ZB-681	5056-181
	<b>C</b> 10.0mm	N/A	Diamond	<b>JMB-682</b>	ZB-682	5056-182

**OSTEON® - STAINLESS STEEL**  
Type - Wire Pass Drills 38mm

	Head Size	Flutes	Head Material	Judd Ref	MicroAire® Ref	Zimmer® Ref
	<b>A</b> 1.0mm	2	S/Steel	<b>JMB-684</b>	ZB-684	5056-184
	<b>B</b> 1.5mm	2	S/Steel	<b>JMB-685</b>	ZB-685	5056-185
	<b>C</b> 2.0mm	2	S/Steel	<b>JMB-686</b>	ZB-686	5056-186

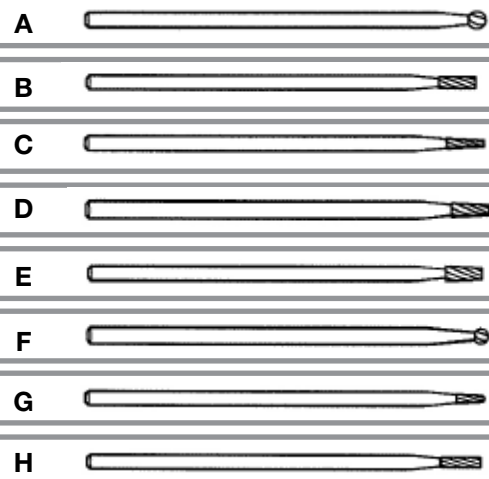
**ZIMMER® Type - Oral Carbide Burs**

	Cat No	Head Dia	Flutes	Length
A	<b>JZB-70</b>	2.3 mm	6	51.0 mm
B	<b>JZB-71</b>	1.6 mm	6	51.0 mm
C	<b>JZB-72</b>	1.2 mm	6	51.0 mm
D	<b>JZB-73</b>	1.6 mm	6	51.0 mm
E	<b>JZB-74</b>	2.1 mm	6	51.0 mm
F	<b>JZB-75</b>	1.8 mm	6	51.0 mm
G	<b>JZB-76</b>	1.2 mm	6	51.0 mm
H	<b>JZB-77</b>	1.7 mm	6	51.0 mm

**ZIMMER® Type - Straight Shank Burs**

	Cat No	Head Dia	Flutes	Length
A	<b>JZB-226</b> Carbide	3.0 mm	6	73.0 mm
B	<b>JZB-228</b> Carbide	4.0 mm	8	70.0 mm
C	<b>JZB-232</b> Carbide	6.5 mm	8	70.0 mm
D	<b>JZB-262</b> Diamond	3.0 mm	N/A	73.0 mm
E	<b>JZB-264</b> Diamond	4.0 mm	N/A	70.0 mm

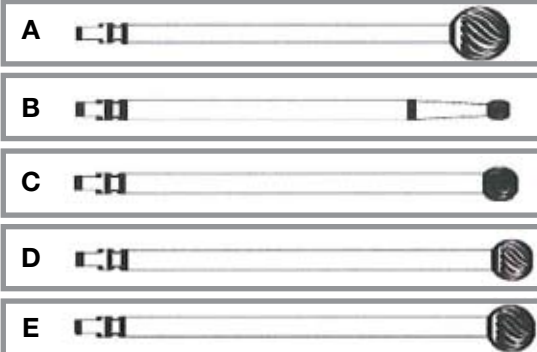
**XOMED™/MEDTRONIC™  
Type - Round Burs - Stainless Steel**

	Cat No	Head Dia	Flutes	Length
A	<b>JM-SO181</b>	7.0 mm	12	51mm
B	<b>JM-SO182</b>	2.3 mm	6	51mm
C	<b>JM-SO180</b>	4.0 mm	8	51mm
D	<b>JM-SO183</b>	4.8 mm	10	51mm
E	<b>JM-SO179</b>	5.5 mm	8	64mm

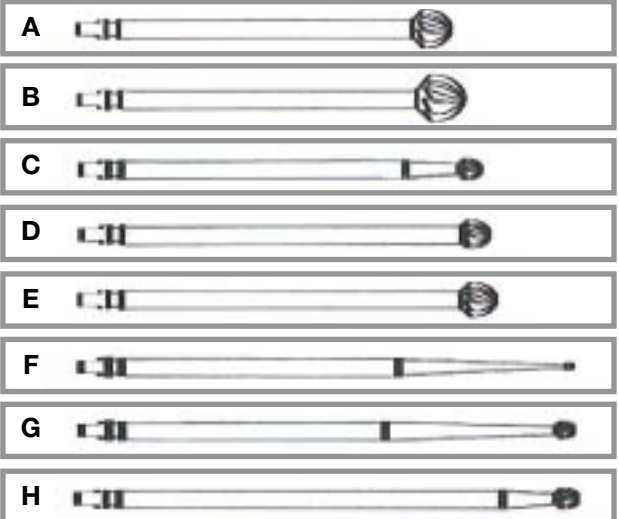
**XOMED™/MEDTRONIC™  
Type - Acorn Burs - Stainless Steel**

	Cat No	Head Dia	Flutes	Length
A	<b>JM-S2502</b>	5.0mm	8	49.5mm
B	<b>JM-S2503</b>	6.0 mm	8	51mm
C	<b>JM-S2506</b>	2.7mm	8	64mm
D	<b>JM-S2511</b>	3.7 mm	8	64mm
E	<b>JM-S2507</b>	4.6mm	8	64mm
F	<b>JM-S2509</b>	1.0 mm	6	65mm
G	<b>JM-S2508</b>	2.3mm	8	64mm
H	<b>JM-S2501</b>	2.7 mm	8	66mm

**STRYKER®**  
Type - Oral Carbide Burs

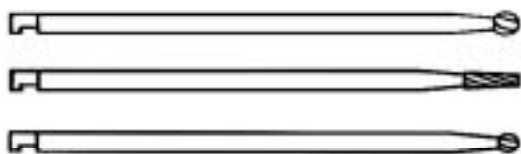

	Head Size	Length	Judd Ref
<b>A</b>	2.3mm	44.8mm	<b>JK-70</b>
<b>B</b>	1.6mm	44.8mm	<b>JK-73</b>
<b>C</b>	1.9mm	44.8mm	<b>JK-75</b>

**ZIMMER®**  
Type - Long Carbide Burs

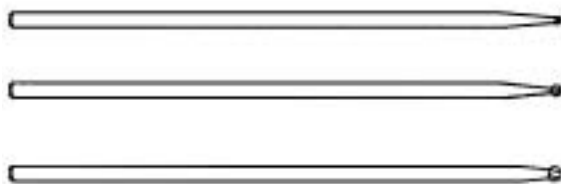

	Head Size	Length	Judd Ref
<b>A</b>	1.0mm	73.0mm	<b>JZB-220</b>
<b>B</b>	1.5mm	73.0mm	<b>JZB-222</b>
<b>C</b>	2.0mm	73.0mm	<b>JZB-224</b>

**ZIMMER®**  
Type - Long Diamond Burs

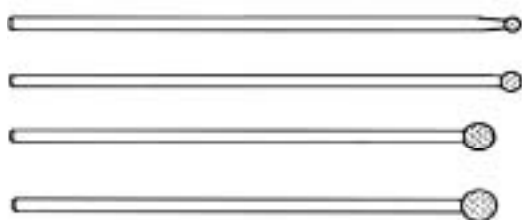

	Head Size	Length	Judd Ref
<b>A</b>	2.0mm	73.0mm	<b>JZB-260</b>
<b>B</b>	3.0mm	73.0mm	<b>JZB-262</b>
<b>C</b>	4.0mm	70.0mm	<b>JZB-264</b>
<b>D</b>	5.0mm	70.0mm	<b>JZB-266</b>

**STRYKER®**  
Type - Fluted Otology Burs



	Head Size	Length	Judd Ref
<b>A</b>	1.0mm	54.0mm	<b>JK-60</b>
<b>B</b>	1.5mm	54.0mm	<b>JK-61</b>
<b>C</b>	2.0mm	54.0mm	<b>JK-62</b>
<b>D</b>	2.3mm	54.0mm	<b>JK-63</b>
<b>E</b>	3.0mm	54.0mm	<b>JK-64</b>
<b>F</b>	4.0mm	54.0mm	<b>JK-65</b>

**STRYKER®**  
Type - Diamond Otology Burs

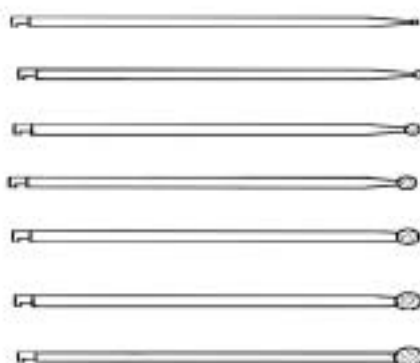

	Head Size	Length	Judd Ref
<b>A</b>	1.0mm	54.0mm	<b>JK-40</b>
<b>B</b>	1.5mm	54.0mm	<b>JK-41</b>
<b>C</b>	2.0mm	54.0mm	<b>JK-42</b>
<b>D</b>	2.5mm	54.0mm	<b>JK-43</b>
<b>E</b>	3.0mm	54.0mm	<b>JK-44</b>
<b>F</b>	3.5mm	54.0mm	<b>JK-45</b>
<b>G</b>	4.0mm	54.0mm	<b>JK-46</b>

## REPLACEMENT BLADES - Full range of Hub fittings available for:

### Micro-Aire® - Type Reciprocating Blades **A**

Cat No	Blade Length	Blade Thickness
--------	--------------	-----------------

<b>J1400-001</b>	25.4 mm	.36 mm
------------------	---------	--------

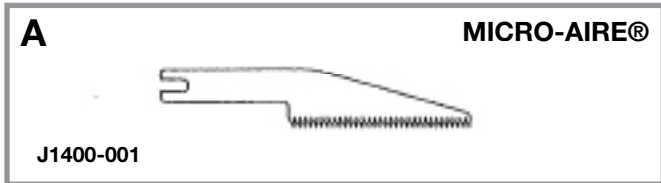

### Micro-Aire® - Type Micro Sagittal Blades **B**

Cat No	Blade Depth	Blade Width	Blade Thickness
--------	-------------	-------------	-----------------

<b>J1200-005</b>	19.8 mm	8.9 mm	.26 mm
------------------	---------	--------	--------

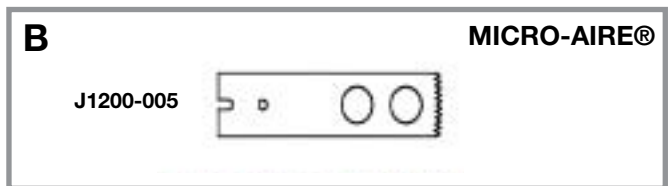

### Hall/Zimmer® - Type Small Reciprocating Blades **C**

Cat No	Blade Length	Blade Thickness	Blade Height
--------	--------------	-----------------	--------------

<b>JZR-120</b>	25.4 mm	.4 mm	8.5 mm
<b>JZR-051</b>	17.0 mm	.5 mm	4.0 mm
<b>JZR-052</b>	23.1 mm	.5 mm	5.0 mm

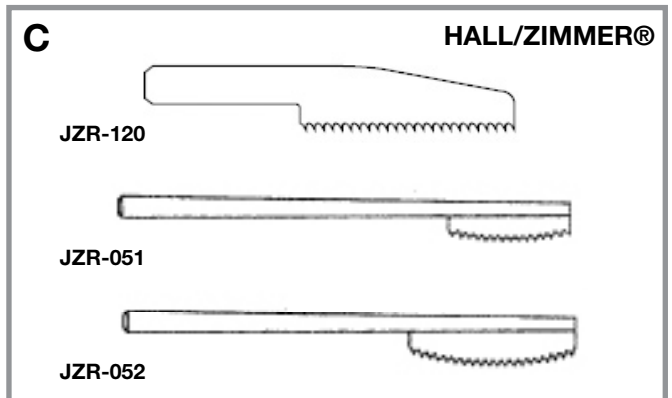

### Stryker®/Command® - Type Saw Blades **D**

Cat No	Blade Depth	Blade Width	Blade Thickness
--------	-------------	-------------	-----------------

<b>JSP-051</b>	18.5 mm	6.5 mm	.38 mm
<b>JSP-212</b>	18.0 mm	5.5 mm	.38 mm

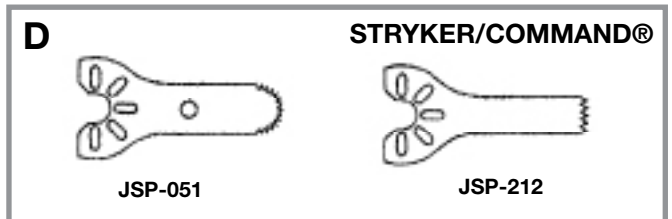

### Zimmer® - Type Angled Oscillating Blades **E**

Cat No	Blade Depth	Blade Width	Blade Thickness
--------	-------------	-------------	-----------------

<b>JZO-069</b>	12.7 mm	10.0 mm	.4 mm
----------------	---------	---------	-------

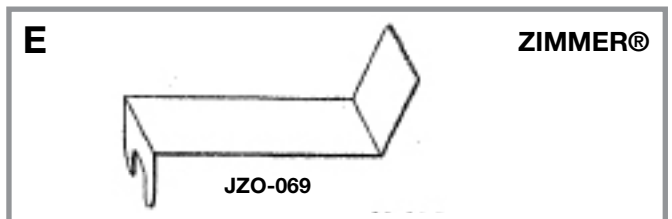

### Micro Choice® - Type Flat Sagittal Blades **F**

Cat No	Blade Depth	Blade Width	Blade Thickness
--------	-------------	-------------	-----------------

<b>JZS-218</b>	25.5 mm	9.5 mm	.6 mm
<b>JZS-238</b>	25.5 mm	9.5 mm	.4 mm

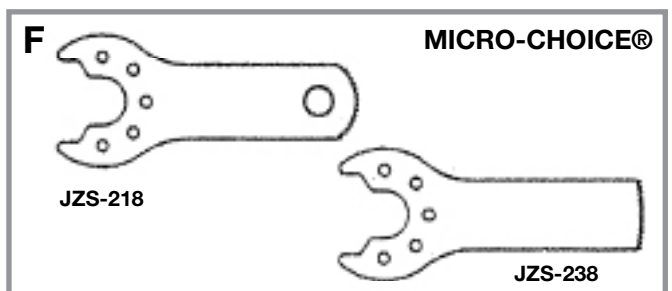

- LINVATEC/HALL®
- MICRO-AIRE®
- DESOUTTER®
- XOMED™
- ZIMMER®
- COLIBRI™
- 3M®
- OSTEON®
- STRYKER®